



# BEADS

Beads offer the highest standard available on the market. The high-quality precision cutting and the clear through-hole achieve immense brilliance and clarity. Rounded hole edges reduce the wear on thread and increase the durability of designs. They are available in the latest fashion colors, effects, and cuts.

The wide range of colors and effects opens up endless possibilities for different combinations and designs. The main application techniques are beading, wiring, stringing, and weaving.



## ALPHABETICAL ORDER

Air Blue Opal (285)  
 Amethyst (204)  
 Amethyst Aurore Boreale (204 AB)  
 Amethyst Shimmer (204 SHIM)  
 Amethyst Shimmer 2x (204 SHIM2)  
 Aquamarine (202)  
 Aquamarine Aurore Boreale (202 AB)  
 Aquamarine Satin (202 SAT)\*  
 Black Diamond (215)  
 Black Diamond Aurore Boreale (215 AB)  
 Black Diamond Shimmer (215 SHIM)  
 Black Diamond Shimmer 2x (215 SHIM2)  
 Blue Zircon (229)  
 Blue Zircon Aurore Boreale (229 AB)  
 Blush Rose (257)  
 Blush Rose Aurore Boreale (257 AB)  
 Burgundy (515)  
 Capri Blue (243)  
 Capri Blue Aurore Boreale (243 AB)  
 Chrysolite (238)  
 Chrysolite Aurore Boreale (238 AB)  
 Chrysolite Opal (294)  
 Citrine (249)  
 Crystal (001)  
 Crystal Antique Pink (001 ANTP)\*  
 Crystal Astral Pink (001 API)  
 Crystal Aurore Boreale (001 AB)  
 Crystal Aurore Boreale 2x (001 AB2)  
 Crystal Aurore Boreale FC (001 AB FC)  
 Crystal Aurore Boreale Satin (001 AB SAT)\*  
 Crystal Blue Shade (001 BLSH)\*  
 Crystal Bermuda Blue (001 BBL)\*  
 Crystal Bronze Shade (001 BRSH)\*  
 Crystal Bronze Shade FC (001 BRSH FC)\*  
 Crystal Comet Argent Light (001 CAL)\*  
 Crystal Comet Argent Light FC (001 CAL FC)\*  
 Crystal Copper (001 COP)\*  
 Crystal Dorado (001 DOR)\*  
 Crystal Dorado 2x (001 DOR2)\*  
 Crystal Golden Shadow (001 GSHA)  
 Crystal Heliotrope (001 HEL)\*  
 Crystal Iridescent Green (001 IRIG)\*  
 Crystal Iridescent Green 2x (001 IRIG2)\*  
 Crystal Iridescent Green FC (001 IRIG FC)\*  
 Crystal Light Chrome (001 LTCH)\*  
 Crystal Light Chrome 2x (001 LTCH2)\*  
 Crystal Lilac Shadow (001 LLSH)  
 Crystal Luminous Green (001 LUMG)\*  
 Crystal Metallic Blue (001 METBL)\*  
 Crystal Metallic Blue 2x (001 METBL2)\*  
 Crystal Metallic Blue FC (001 METBL2 FC)\*  
 Crystal Metallic Light Gold (001 MLGLD)\*  
 Crystal Metallic Light Gold 2x (001 MLGLD2)\*  
 Crystal Metallic Sunshine (001 METSH)\*  
 Crystal Metallic Sunshine 2x (001 METSH2)\*  
 Crystal Moonlight (001 MOL)  
 Crystal Paradise Shine (001 PARSH)\*  
 Crystal Paradise Shine 2x (001 PARSH2)\*  
 Crystal Rainbow Dark 2x (001 RABDK)\*  
 Crystal Red Magma (001 REDM)\*  
 Crystal Rose Gold (001 ROGL)\*

Crystal Rose Gold 2x (001 ROGL2)\*  
 Crystal Satin (001 SAT)\*  
 Crystal Scarabaeus Green (001 SCGR)\*\*/\*\*  
 Crystal Shimmer (001 SHIM)  
 Crystal Shimmer 2x (001 SHIM2)  
 Crystal Silver Night (001 SINI)\*  
 Crystal Silver Night 2x (001 SINI2)\*  
 Crystal Silver Patina (001 SILPA)\*  
 Crystal Silver Shade (001 SSHA)  
 Crystal Vitrail Medium (001 VM)\*  
 Cyclamen Opal (398)  
 Dark Indigo (288)  
 Denim Blue (266)  
 Emerald (205)  
 Emerald Aurore Boreale (205 AB)  
 Erinite (360)  
 Erinite Aurore Boreale (360 AB)  
 Erinite Shimmer (360 SHIM)  
 Erinite Shimmer 2x (360 SHIM2)  
 Fern Green (291)  
 Fireopal (237)  
 Fireopal Aurore Boreale (237 AB)  
 Fuchsia (502)  
 Fuchsia Aurore Boreale (502 AB)  
 Graphite (253)  
 Graphite Aurore Boreale (253 AB)  
 Greige (284)  
 Hyacinth (236)  
 Hyacinth Aurore Boreale (236 AB)  
 Indian Pink (289)  
 Indian Sapphire (217)  
 Indian Sapphire Aurore Boreale (217 AB)  
 Indicolite (379)  
 Indicolite Aurore Boreale (379 AB)  
 Jet (280)  
 Jet Aurore Boreale (280 AB)  
 Jet Hematite (280 HEM)\*  
 Jet Hematite 2x (280 HEM2)\*  
 Jonquil (213)  
 Jonquil Aurore Boreale (213 AB)  
 Jonquil Satin (213 SAT)\*  
 Light Amethyst (212)  
 Light Amethyst Aurore Boreale (212 AB)  
 Light Azure (361)  
 Light Azure Aurore Boreale (361 AB)  
 Light Colorado Topaz (246)  
 Light Colorado Topaz Aurore Boreale (246 AB)  
 Light Colorado Topaz Shimmer (246 SHIM)  
 Light Colorado Topaz Shimmer 2x (246 SHIM2)  
 Light Grey Opal (383)  
 Light Peach (362)  
 Light Peach Aurore Boreale (362 AB)  
 Light Peach Satin (362 SAT)\*  
 Light Rose (223)  
 Light Rose Aurore Boreale (223 AB)  
 Light Rose Satin (223 SAT)\*  
 Light Sapphire (211)  
 Light Sapphire Aurore Boreale (211 AB)  
 Light Sapphire Shimmer (211 SHIM)  
 Light Sapphire Shimmer 2x (211 SHIM2)  
 Light Siam (227)

Light Siam Aurore Boreale (227 AB)  
 Light Siam Satin (227 SAT)\*  
 Light Siam Shimmer (227 SHIM)  
 Light Siam Shimmer 2x (227 SHIM2)  
 Light Silk (261)  
 Light Smoked Topaz (221)  
 Light Smoked Topaz Aurore Boreale (221 AB)  
 Light Topaz (226)  
 Light Topaz Aurore Boreale (226 AB)  
 Light Topaz Shimmer (226 SHIM)  
 Light Topaz Shimmer 2x (226 SHIM2)  
 Light Turquoise (263)  
 Majestic Blue (296)<sup>1</sup>  
 Majestic Blue Aurore Boreale (296 AB)  
 Montana (207)  
 Montana Aurore Boreale (207 AB)  
 Olivine (228)  
 Olivine Aurore Boreale (228 AB)  
 Pacific Opal (390)  
 Padparadscha (542)  
 Peridot (214)  
 Peridot Aurore Boreale (214 AB)  
 Provence Lavender (283)  
 Purple Velvet (277)  
 Purple Velvet Aurore Boreale (277 AB)  
 Rosaline (508)  
 Rose (209)  
 Rose Aurore Boreale (209 AB)  
 Rose Satin (209 SAT)\*  
 Rose Peach (262)  
 Rose Water Opal (395)  
 Ruby (501)  
 Ruby Aurore Boreale (501 AB)  
 Sapphire (206)  
 Sapphire Aurore Boreale (206 AB)  
 Scarlet (276)  
 Scarlet Aurore Boreale (276 AB)  
 Siam (208)  
 Siam Aurore Boreale (208 AB)  
 Silk (391)  
 Smoked Topaz (220)  
 Smoked Topaz Aurore Boreale (220 AB)  
 Smoky Mauve (265)  
 Smoky Mauve Aurore Boreale (265 AB)  
 Sunflower (292)  
 Tangerine (259)  
 Tanzanite (539)  
 Tanzanite Aurore Boreale (539 AB)  
 Topaz (203)  
 Topaz Aurore Boreale (203 AB)  
 Turquoise (267)  
 Turquoise Aurore Boreale (267 AB)  
 Vintage Rose (319)  
 Violet (371)  
 Violet Aurore Boreale (371 AB)  
 White Alabaster (281)  
 White Opal (234)  
 White Opal Aurore Boreale (234 AB)  
 Yellow Opal (231)  
 Yellow Opal Aurore Boreale (231 AB)

For details on available colors and effects for each article within the product groups, please see the product matrix of the respective item in the Collection 2018.

For color and effect samples, please see the corresponding color chart.

Please check the Swarovski Collection 2018 for all available crystal color and AB coating variations.

The plating resistance of effects is tested according to Swarovski's plating guidelines (SWAROVSKI-PROFESSIONAL.COM). Customers are advised to carry out their own tests if their plating parameters diverge from Swarovski plating guidelines.

\* Crystals are not resistant to plating and similar processing.

\*\*\* designed by Jean Paul Gaultier

<sup>1</sup> Majestic Blue's intense ultramarine hue is difficult to recreate accurately in print due to the fact that the CMYK color spectrum is used in the printing process.

In order to get a truer impression of its color, please use RGB digital pictures or, ideally, ask for actual samples.

Classic Colors/Effects: This color range offers a wide choice of traditional Swarovski crystal colors and effects.

Exclusive Colors/Effects: This color range is offered exclusively by Swarovski.

Colors and effects can appear different when illuminated with different light sources. Swarovski uses standard light source D50 for color decision and comparison. Slight changes in shades are unavoidable. Colors may vary according to cut and foiling.

The composition of Advanced Crystal is compliant with regulatory industry norms and laws regarding the restriction or prohibition of certain substances in the most relevant segments of our customers. Please note that the compliance of the crystal colors Citrine, Fireopal, Hyacinth, Light Siam, Siam, and Yellow Opal varies according to certain industry regulations. Those regulations are indicated with \* in the compliance overview. Indian Siam and Scarlet (option to Lt. Siam) conform to all CLEAR-lists. For further information please visit SWAROVSKI-PROFESSIONAL.COM



# SUMMARY

1 2 3  
  
**CORE ASSORTMENT**  
**5000**  
 2, 3, 4, 5, 6, 7, 8, 10,  
 12, 14 mm

  
**5003**  
 6, 8, 10, 12, 14 mm

  
**5005**  
 8, 12, 16 mm

  
**5020**  
 6, 8, 10 mm

  
**5028/4**  
 6, 8, 10 mm

**CORE ASSORTMENT**  
  
**5040**  
 4, 6, 8, 12 mm

  
**5041**  
 18 mm

  
**5045**  
 6, 8 mm

  
**5058**  
 10, 14 mm

  
**5060**  
 5.5, 7.5 mm

  
**5061**  
 5.5, 7.5 mm

  
**5062**  
 5.5, 7.5 mm

  
**5200**  
 6x4, 7.5x5 mm

1 2 3  
  
**5305**  
 5, 6 mm

**CORE ASSORTMENT**  
  
**5328**  
 2.5, 3, 4, 5, 6, 8, 10 mm

  
**5378**  
 14, 18 mm

  
**5500**  
 9x6, 12x8 mm

  
**5514**  
 8x5.5, 10x7 mm

  
**5515**  
 14x9.5, 18x12.5 mm

  
**5523**  
 12, 16 mm

  
**5540**  
 12, 17 mm

  
**5541**  
 11, 15 mm

  
**5542**  
 8, 11 mm

  
**5601**  
 4, 6, 8, 10, 12 mm

  
**5621**  
 14, 18 mm

  
**5624**  
 10, 14 mm

1 2 3  
  
**5714**  
 8, 12 mm

  
**5727**  
 14 mm

  
**5728**  
 12 mm

  
**5741**  
 8, 12 mm

  
**5742**  
 8, 10 mm

  
**5744**  
 6, 8 mm

  
**5747**  
 12x6, 16x8 mm

  
**5750**  
 13, 19 mm

  
**5752**  
 8, 12 mm

  
**5754**  
 6, 8, 10, 12 mm

  
**5950**  
 15, 30 mm

  
**5951**  
 15, 30 mm

**CORE ASSORTMENT**

5000 Classic Bead

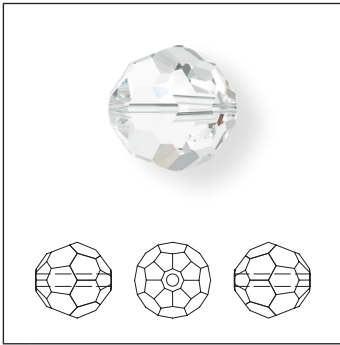

| Size | 2 mm | 3 mm | 4 mm | 5 mm | 6 mm | 7 mm | 8 mm | 10 mm | 12 mm | 14 mm |
|------|------|------|------|------|------|------|------|-------|-------|-------|
|------|------|------|------|------|------|------|------|-------|-------|-------|

**Crystal**

Crystal (001)

**Colors**

**Plain Colors**





















- Amethyst (204)
- Aquamarine (202)
- Black Diamond (215)
- Blue Zircon (229)
- Blush Rose (257)
- Capri Blue (243)
- Chrysolite (238)
- Dark Indigo (288)
- Denim Blue (266)
- Emerald (205)
- Erinite (360)
- Fern Green (291)
- Fireopal (237)
- Fuchsia (502)
- Graphite (253)
- Greige (284)
- Indian Pink (289)
- Indicolite (379)
- Jet (280)
- Jonquil (213)
- Light Amethyst (212)
- Light Azore (361)
- Light Colorado Topaz (246)
- Light Rose (223)
- Light Sapphire (211)
- Light Siam (227)
- Light Silk (261)
- Light Topaz (226)
- Light Turquoise (263)
- Majestic Blue (296)
- Montana (207)
- Olivine (228)
- Padparadscha (542)
- Peridot (214)
- Purple Velvet (277)
- Rose (209)

|                            |   |   |   |   |   |   |   |   |   |   |
|----------------------------|---|---|---|---|---|---|---|---|---|---|
| Crystal (001)              | ◆ | ◆ | ◆ | ◆ | ◆ | ◆ | ◆ | ◆ | ◆ | ◆ |
| Amethyst (204)             | ◆ | ◆ | ◆ | ◆ | ◆ | ◆ | ◆ | ◆ |   |   |
| Aquamarine (202)           | ◆ | ◆ | ◆ | ◆ | ◆ | ◆ | ◆ | ◆ |   |   |
| Black Diamond (215)        |   | ■ | ■ |   | ■ |   | ■ | ■ |   |   |
| Blue Zircon (229)          |   |   | ■ |   | ■ |   | ■ |   |   |   |
| Blush Rose (257)           |   |   | ■ |   | ■ |   | ■ |   |   |   |
| Capri Blue (243)           |   |   | ■ |   | ■ |   | ■ |   |   |   |
| Chrysolite (238)           |   |   | ■ |   | ■ |   | ■ |   |   |   |
| Dark Indigo (288)          |   |   | ■ |   | ■ |   | ■ | ■ |   |   |
| Denim Blue (266)           |   |   | ■ |   | ■ |   | ■ |   |   |   |
| Emerald (205)              | ◆ | ◆ | ◆ | ◆ | ◆ | ◆ | ◆ |   |   |   |
| Erinite (360)              |   |   | ■ |   | ■ |   | ■ |   |   |   |
| Fern Green (291)           |   |   | ■ |   | ■ |   | ■ |   |   |   |
| Fireopal (237)             |   |   | ■ |   | ■ |   | ■ |   |   |   |
| Fuchsia (502)              | ■ | ■ |   |   | ■ |   | ■ |   |   |   |
| Graphite (253)             |   |   | ■ |   | ■ |   | ■ |   |   |   |
| Greige (284)               |   |   | ■ |   | ■ |   | ■ |   |   |   |
| Indian Pink (289)          |   |   | ■ |   | ■ |   | ■ |   |   |   |
| Indicolite (379)           |   |   | ■ |   | ■ |   | ■ |   |   |   |
| Jet (280)                  | ◆ | ◆ | ◆ | ◆ | ◆ | ◆ | ◆ | ◆ | ■ | ■ |
| Jonquil (213)              |   |   | ■ |   | ■ |   | ■ |   |   |   |
| Light Amethyst (212)       |   |   | ■ |   | ■ |   | ■ |   |   |   |
| Light Azore (361)          |   |   | ■ |   | ■ |   | ■ |   |   |   |
| Light Colorado Topaz (246) | ◆ | ◆ | ◆ | ◆ | ◆ | ◆ | ◆ |   |   |   |
| Light Rose (223)           |   | ■ | ■ |   | ■ |   | ■ |   |   |   |
| Light Sapphire (211)       |   |   | ■ |   | ■ |   | ■ |   |   |   |
| Light Siam (227)           |   | ■ | ■ |   | ■ |   | ■ | ■ |   |   |
| Light Silk (261)           |   |   | ■ |   | ■ |   | ■ |   |   |   |
| Light Topaz (226)          |   |   | ■ |   | ■ |   | ■ | ■ |   |   |
| Light Turquoise (263)      |   | ■ | ■ |   | ■ |   | ■ |   |   |   |
| Majestic Blue (296)        | ■ | ■ | ■ |   | ■ |   | ■ | ■ |   |   |
| Montana (207)              |   |   | ■ |   | ■ |   | ■ |   |   |   |
| Olivine (228)              |   |   | ■ |   | ■ |   | ■ |   |   |   |
| Padparadscha (542)         |   |   | ■ |   | ■ |   | ■ |   |   |   |
| Peridot (214)              |   |   | ■ |   | ■ |   | ■ |   |   |   |
| Purple Velvet (277)        |   |   | ■ |   | ■ |   | ■ |   |   |   |
| Rose (209)                 |   |   | ■ |   | ■ |   | ■ |   |   |   |

◆ Core Assortment

|   | 5000 |      |      |      |      |      |      |      |       |       |       |
|---|------|------|------|------|------|------|------|------|-------|-------|-------|
|   | Size | 2 mm | 3 mm | 4 mm | 5 mm | 6 mm | 7 mm | 8 mm | 10 mm | 12 mm | 14 mm |
| Sapphire (206)                            |      |      |      | ■    |      | ■    |      | ■    |       |       |       |
| Scarlet (276)                             |      | ◆    | ◆    | ◆    | ◆    | ◆    | ◆    | ◆    | ◆     |       |       |
| Siam (208)                                |      | ■    | ■    |      |      | ■    |      | ■    | ■     |       |       |
| Silk (391)                                |      |      |      |      |      |      |      |      |       |       |       |
| Smoked Topaz (220)                        |      |      |      | ■    |      | ■    |      | ■    |       |       |       |
| Smoky Mauve (265)                         |      |      |      | ■    |      | ■    |      | ■    |       |       |       |
| Tanzanite (539)                           |      |      |      | ■    |      | ■    |      | ■    |       |       |       |
| Topaz (203)                               |      |      |      | ■    |      | ■    |      | ■    |       |       |       |
| Turquoise (267)                           |      |      |      | ■    |      | ■    |      | ■    |       |       |       |
| Vintage Rose (319)                        |      |      |      | ■    |      | ■    |      | ■    |       |       |       |
| Violet (371)                              |      |      |      | ■    |      | ■    |      | ■    |       |       |       |
| White Alabaster (281)                     |      |      |      | ■    |      | ■    |      | ■    |       |       |       |
| <b>Opal Colors</b>                        |      |      |      |      |      |      |      |      |       |       |       |
| Cyclamen Opal (398)                       |      |      |      | ■    |      | ■    |      | ■    |       |       |       |
| Pacific Opal (390)                        |      |      |      | ■    |      | ■    |      | ■    |       |       |       |
| White Opal (234)                          |      | ■    | ■    |      |      | ■    |      | ■    |       |       |       |
| Yellow Opal (231)                         |      |      | ■    |      |      | ■    |      | ■    |       |       |       |
| <b>Crystal Effects</b>                    |      |      |      |      |      |      |      |      |       |       |       |
| <b>Transparent Effects</b>                |      |      |      |      |      |      |      |      |       |       |       |
| Crystal AB (001 AB)                       | ■    | ■    | ■    | ■    | ■    | ■    | ■    | ■    | ■     | ■     | ■     |
| Crystal Antique Pink (001 ANTP)           |      |      |      | ■    |      | ■    |      | ■    |       |       |       |
| Crystal Blue Shade (001 BLSH)             |      | ■    | ■    |      |      | ■    |      | ■    |       |       |       |
| Crystal Bronze Shade (001 BRSH)           |      | ■    | ■    |      |      | ■    |      | ■    |       |       |       |
| Crystal Copper (001 COP)                  |      |      |      | ■    |      | ■    |      | ■    |       |       |       |
| Crystal Golden Shadow (001 GSHA)          | ■    | ■    | ■    |      |      | ■    |      | ■    | ■     |       |       |
| Crystal Lilac Shadow (001 LISH)           |      |      |      | ■    |      | ■    |      | ■    |       |       |       |
| Crystal Moonlight (001 MOL)               | ■    |      |      | ■    |      | ■    |      | ■    |       |       |       |
| Crystal Paradise Shine (001 PARSH)        |      |      |      | ■    |      | ■    |      | ■    |       |       |       |
| Crystal Satin (001 SAT)                   |      |      |      | ■    |      | ■    |      | ■    |       |       |       |
| Crystal Silver Night (001 SINI)           |      | ■    | ■    |      |      | ■    |      | ■    |       |       |       |
| Crystal Silver Shade (001 SSHA)           | ■    | ■    | ■    |      |      | ■    |      | ■    |       |       |       |
| Crystal Vitrail Medium (001 VM)           |      |      |      | ■    |      | ■    |      | ■    |       |       |       |
| <b>Metallic Effects</b>                   |      |      |      |      |      |      |      |      |       |       |       |
| Crystal Dorado (001 DOR)                  |      |      |      | ■    |      | ■    |      | ■    |       |       |       |
| Crystal Iridescent Green (001 IRIG)       |      | ■    | ■    |      |      | ■    |      | ■    |       |       |       |
| Crystal Light Chrome (001 LTCH)           |      | ■    | ■    |      |      | ■    |      | ■    |       |       |       |
| Crystal Metallic Light Gold 2x (001 MLG2) | ■    |      |      |      |      | ■    |      | ■    |       |       |       |
| Crystal Metallic Sunshine (001 METSH)     |      | ■    | ■    |      |      | ■    |      | ■    |       |       |       |
| Crystal Rose Gold (001 ROGL)              |      | ■    | ■    |      |      | ■    |      | ■    |       |       |       |



| 5000  |  | Size |      |      |      |      |      |      |       |       |       |  |
|---|--|------|------|------|------|------|------|------|-------|-------|-------|--|
|   |  | 2 mm | 3 mm | 4 mm | 5 mm | 6 mm | 7 mm | 8 mm | 10 mm | 12 mm | 14 mm |  |
| <b>Full Coating</b>   |  |      |      |      |      |      |      |      |       |       |       |  |
|    | Crystal AB FC (001 AB FC)                  |      |      | ■    |      | ■    |      | ■    |       |       |       |  |
|    | Crystal Astral Pink FC (001 API FC)        |      |      | ■    |      | ■    |      | ■    |       |       |       |  |
|    | Crystal Bronze Shade FC (001 BRSH FC)      |      |      | ■    |      | ■    |      | ■    |       |       |       |  |
|    | Crystal Comet Argent Light FC (001 CAL FC) |      |      | ■    |      | ■    |      | ■    |       |       |       |  |
|    | Crystal Iridescent Green FC (001 IRIG FC)  |      |      | ■    |      | ■    |      | ■    |       |       |       |  |
|    | Crystal Metallic Blue FC (001 METBL FC)    |      |      | ■    |      | ■    |      | ■    |       |       |       |  |
| <b>Color Effects</b>  |  |      |      |      |      |      |      |      |       |       |       |  |
| <b>Transparent Effects</b>  |  |      |      |      |      |      |      |      |       |       |       |  |
|    | Amethyst AB (204 AB)                       |      |      | ■    |      | ■    |      | ■    |       |       |       |  |
|  | Aquamarine AB (202 AB)                     |      |      | ■    |      | ■    |      | ■    |       |       |       |  |
|  | Black Diamond Shimmer (215 SHIM)           |      |      | ■    |      | ■    |      | ■    |       |       |       |  |
|  | Erinite Shimmer (360 SHIM)                 |      |      | ■    |      | ■    |      | ■    |       |       |       |  |
|  | Jet AB (280 AB)                            |      |      | ■    |      | ■    |      | ■    |       |       |       |  |
|  | Light Colorado Topaz Shimmer (246 SHIM)    |      |      | ■    |      | ■    |      | ■    |       |       |       |  |
|  | Light Rose AB (223 AB)                     |      |      | ■    |      | ■    |      | ■    |       |       |       |  |
|  | Light Sapphire Shimmer (211 SHIM)          |      |      | ■    |      | ■    |      | ■    |       |       |       |  |
|  | Light Siam AB (227 AB)                     |      |      | ■    |      | ■    |      | ■    |       |       |       |  |
|  | Light Siam Shimmer (227 SHIM)              |      |      | ■    |      | ■    |      | ■    |       |       |       |  |
|  | Light Topaz Shimmer (226 SHIM)             |      |      | ■    |      | ■    |      | ■    |       |       |       |  |
|  | Rose AB (209 AB)                           |      |      | ■    |      | ■    |      | ■    |       |       |       |  |
| <b>Metallic Effects</b>   |  |      |      |      |      |      |      |      |       |       |       |  |
|  | Jet Hematite (280 HEM)                     |      | ■    | ■    |      | ■    |      | ■    |       |       |       |  |
|  | Jet Hematite 2x (280 HEM2)                 |      |      | ■    |      | ■    |      | ■    |       |       |       |  |

5003

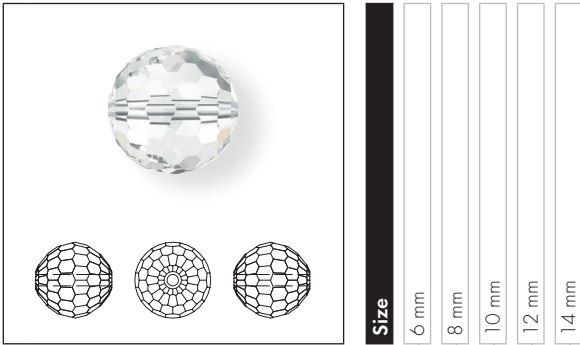

| Crystal                    | 6 mm | 8 mm | 10 mm | 12 mm | 14 mm |
|----------------------------|------|------|-------|-------|-------|
| Crystal (001)              | ■    | ■    | ■     | ■     | ■     |
| <b>Crystal Effects</b>     |      |      |       |       |       |
| <b>Transparent Effects</b> |      |      |       |       |       |
| Crystal AB (001 AB)        | ■    | ■    | ■     | ■     | ■     |

5005 Chessboard Bead

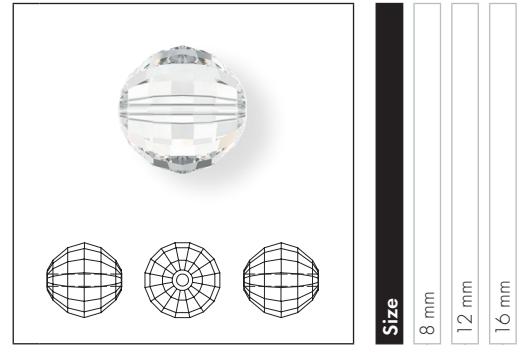

| Crystal                          | 8 mm | 12 mm | 16 mm |
|----------------------------------|------|-------|-------|
| Crystal (001)                    | ■    | ■     | ■     |
| <b>Crystal Effects</b>           |      |       |       |
| <b>Transparent Effects</b>       |      |       |       |
| Crystal AB (001 AB)              | ■    | ■     | ■     |
| Crystal Golden Shadow (001 GSHA) | ■    | ■     | ■     |

5020 Helix Bead

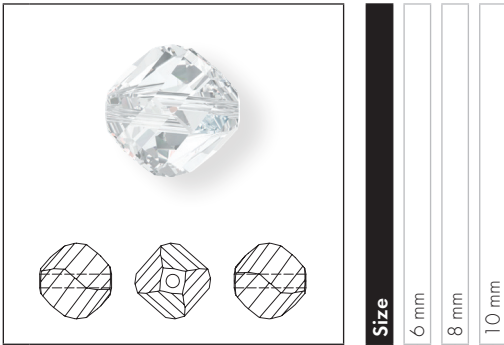

| Crystal                          | 6 mm | 8 mm | 10 mm |
|----------------------------------|------|------|-------|
| Crystal (001)                    | ■    | ■    | ■     |
| <b>Crystal Effects</b>           |      |      |       |
| <b>Transparent Effects</b>       |      |      |       |
| Crystal AB (001 AB)              | ■    | ■    | ■     |
| Crystal Golden Shadow (001 GSHA) | ■    | ■    | ■     |

5028/4 Crystal Globe Bead

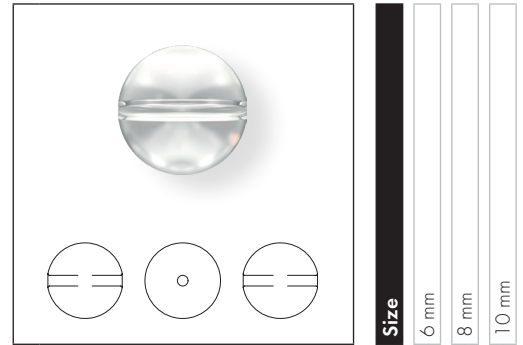

| Crystal                               | 6 mm | 8 mm | 10 mm |
|---------------------------------------|------|------|-------|
| Crystal (001)                         | ■    | ■    | ■     |
| <b>Crystal Effects</b>                |      |      |       |
| <b>Transparent Effects</b>            |      |      |       |
| Crystal AB (001 AB)                   | ■    | ■    | ■     |
| Crystal Golden Shadow (001 GSHA)      | ■    | ■    | ■     |
| <b>Metallic Effects</b>               |      |      |       |
| Crystal Metallic Sunshine (001 METSH) | ■    | ■    | ■     |
| Crystal Iridescent Green (001 IRIG)   | ■    | ■    | ■     |

**CORE ASSORTMENT**

**5040** Briolette Bead

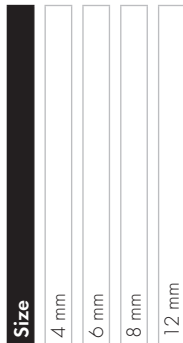

| Crystal                             |         |
|-------------------------------------|---------|
| Crystal (001)                       | ◆ ◆ ◆ ■ |
| Colors                              |         |
| Plain Colors                        |         |
| Amethyst (204)                      | ◆ ◆ ◆   |
| Aquamarine (202)                    | ◆ ◆ ◆   |
| Black Diamond (215)                 | ■ ■ ■   |
| Blush Rose (257)                    | ■ ■ ■   |
| Denim Blue (266)                    | ■ ■ ■   |
| Emerald (205)                       | ◆ ◆ ◆   |
| Erinite (360)                       | ■ ■ ■   |
| Indicolite (379)                    | ■ ■ ■   |
| Jet (280)                           | ◆ ◆ ◆   |
| Light Colorado Topaz (246)          | ◆ ◆ ◆   |
| Light Rose (223)                    | ■ ■ ■   |
| Light Siam (227)                    | ■ ■ ■   |
| Light Turquoise (263)               | ■ ■ ■   |
| Peridot (214)                       | ■ ■ ■   |
| Purple Velvet (277)                 | ■ ■ ■   |
| Scarlet (276)                       | ◆ ◆ ◆   |
| Siam (208)                          | ■ ■ ■   |
| Silk (391)                          | ■ ■ ■   |
| Tanzanite (539)                     | ■ ■ ■   |
| Violet (371)                        | ■ ■ ■   |
| Crystal Effects                     |         |
| Transparent Effects                 |         |
| Crystal AB (001 AB)                 | ■ ■ ■ ■ |
| Crystal Golden Shadow (001 GSHA)    | ■ ■ ■ ■ |
| Crystal Moonlight (001 MOL)         | ■ ■ ■   |
| Crystal Paradise Shine (001 PARSH)  | ■ ■ ■   |
| Crystal Silver Night (001 SINI)     | ■ ■ ■ ■ |
| Crystal Silver Shade (001 SSHA)     | ■ ■ ■ ■ |
| Metallic Effects                    |         |
| Crystal Rainbow Dark 2x (001 RBDK2) | ■ ■ ■   |

**5041** Briolette Bead (large hole)



| Crystal                          |   |
|----------------------------------|---|
| Crystal (001)                    | ■ |
| Crystal Effects                  |   |
| Transparent Effects              |   |
| Crystal AB (001 AB)              | ■ |
| Crystal Golden Shadow (001 GSHA) | ■ |

5045 Rondelle Bead



Size  
6 mm  
8 mm

Crystal

Crystal (001)

Colors

Plain Colors

Emerald (205)

Jet (280)

Crystal Effects

Transparent Effects

Crystal AB (001 AB)

Crystal Silver Night (001 SINI)

Metallic Effects

Crystal Light Chrome (001 LTCH)

5058 Baroque Bead

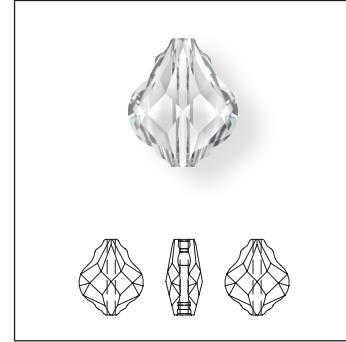

Size  
10 mm  
14 mm

Crystal

Crystal (001)

Colors

Plain Colors

Amethyst (204)

Aquamarine (202)

Dark Indigo (288)

Emerald (205)

Jet (280)

Light Smoked Topaz (221)

Ruby (501)

Crystal Effects

Transparent Effects

Crystal AB (001 AB)

Crystal Golden Shadow (001 GSHA)

Crystal Silver Night (001 SINI)

Metallic Effects

Crystal Rose Gold 2x (001 ROGL2)

**SPIKE BEADS**

**5060 Hexagon Spike Bead**

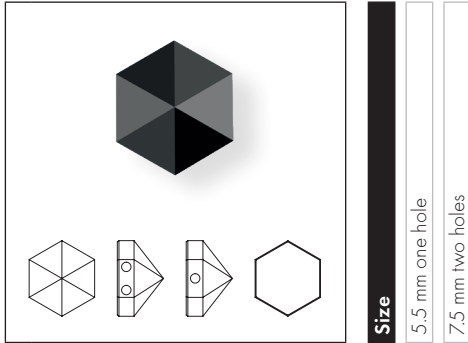

**Size**

5.5 mm one hole

7.5 mm two holes

**Crystal**

Crystal (001)

**Colors**

**Plain Colors**

Jet (280)

**Crystal Effects**

**Transparent Effects**

Crystal AB (001 AB)

Crystal Blue Shade (001 BLSH)

Crystal Golden Shadow (001 GSHA)

Crystal Paradise Shine (001 PARSH)

Crystal Silver Night (001 SINI)

**Metallic Effects**

Crystal Light Chrome (001 LTCH)

Crystal Metallic Blue (001 METBL)

Crystal Metallic Light Gold (001 MLG)

Crystal Rose Gold (001 ROGL)

**Color Effects**

**Metallic Effects**

Jet Hematite (280 HEM)

**5061 Square Spike Bead**

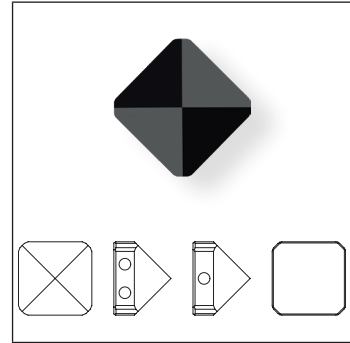

**Size**

5.5 mm one hole

7.5 mm two holes

**Crystal**

Crystal (001)

**Colors**

**Plain Colors**

Jet (280)

**Crystal Effects**

**Transparent Effects**

Crystal AB (001 AB)

Crystal Blue Shade (001 BLSH)

Crystal Golden Shadow (001 GSHA)

Crystal Paradise Shine (001 PARSH)

Crystal Silver Night (001 SINI)

**Metallic Effects**

Crystal Light Chrome (001 LTCH)

Crystal Metallic Blue (001 METBL)

Crystal Metallic Light Gold (001 MLG)

Crystal Rose Gold (001 ROGL)

**Color Effects**

**Metallic Effects**

Jet Hematite (280 HEM)

**5062** Round Spike Bead

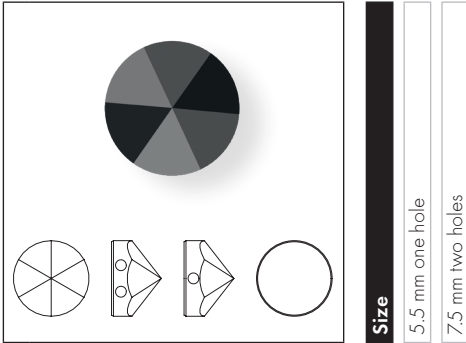

**Size**

5.5 mm one hole

7.5 mm two holes

| Crystal                                |     |
|--|-----|
| Crystal (001)                          | ■ ■ |
| Colors                                 |     |
| Plain Colors                           |     |
| Jet (280)                              | ■ ■ |
| Crystal Effects                        |     |
| Transparent Effects                    |     |
| Crystal AB (001 AB)                    | ■ ■ |
| Crystal Blue Shade (001 BLSH)          | ■ ■ |
| Crystal Golden Shadow (001 GSHA)       | ■ ■ |
| Crystal Paradise Shine (001 PARSH)     | ■ ■ |
| Crystal Silver Night (001 SINI)        | ■ ■ |
| Metallic Effects                       |     |
| Crystal Light Chrome (001 LTCH)        | ■ ■ |
| Crystal Metallic Blue (001 METBL)      | ■ ■ |
| Crystal Metallic Light Gold (001 MILG) | ■ ■ |
| Crystal Rose Gold (001 ROGL)           | ■ ■ |
| Color Effects                          |     |
| Metallic Effects                       |     |
| Jet Hematite (280 HEM)                 | ■ ■ |

5200

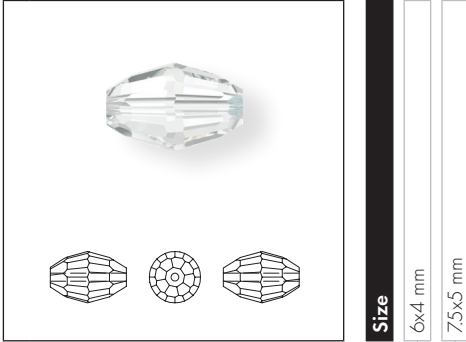

Size

6x4 mm

7,5x5 mm

Crystal

Crystal (001)

Crystal Effects

Transparent Effects

Crystal AB (001 AB)

5305

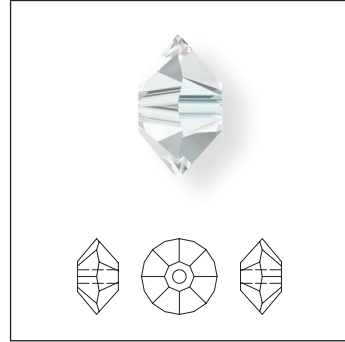

Size

5 mm

6 mm

Crystal

Crystal (001)

Crystal Effects

Transparent Effects

Crystal AB (001 AB)

**CORE ASSORTMENT**

**5328 XILION Bead**

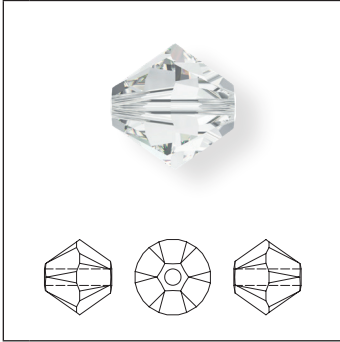

**Crystal**

Crystal (001)

**Colors**

**Plain Colors**

- Amethyst (204)
- Aquamarine (202)
- Black Diamond (215)
- Blue Zircon (229)
- Blush Rose (257)
- Burgundy (515)
- Capri Blue (243)
- Chrysolite (238)
- Citrine (249)
- Dark Indigo (288)
- Denim Blue (266)
- Emerald (205)
- Erinite (360)
- Fern Green (291)
- Fireopal (237)
- Fuchsia (502)
- Graphite (253)
- Greige (284)
- Hyacinth (236)
- Indian Pink (289)
- Indian Sapphire (217)
- Indicolite (379)
- Jet (280)
- Jonquil (213)
- Light Amethyst (212)
- Light Azore (361)
- Light Colorado Topaz (246)
- Light Peach (362)
- Light Rose (223)
- Light Sapphire (211)
- Light Siam (227)
- Light Silk (261)
- Light Smoked Topaz (221)
- Light Topaz (226)
- Light Turquoise (263)
- Majestic Blue (296)

|                            | 2.5 mm | 3 mm | 4 mm | 5 mm | 6 mm | 8 mm | 10 mm |
|----------------------------|--------|------|------|------|------|------|-------|
| Crystal (001)              | ◆      | ◆    | ◆    | ◆    | ◆    | ◆    | ◆     |
| Amethyst (204)             | ◆      | ◆    | ◆    | ◆    | ◆    | ◆    | ◆     |
| Aquamarine (202)           | ◆      | ◆    | ◆    | ◆    | ◆    | ◆    | ◆     |
| Black Diamond (215)        | ■      | ■    | ■    | ■    | ■    | ■    | ■     |
| Blue Zircon (229)          | ■      | ■    | ■    | ■    | ■    | ■    | ■     |
| Blush Rose (257)           | ■      | ■    | ■    | ■    | ■    | ■    | ■     |
| Burgundy (515)             | ■      | ■    | ■    | ■    | ■    | ■    | ■     |
| Capri Blue (243)           | ■      | ■    | ■    | ■    | ■    | ■    | ■     |
| Chrysolite (238)           | ■      | ■    | ■    | ■    | ■    | ■    | ■     |
| Citrine (249)              | ■      | ■    | ■    | ■    | ■    | ■    | ■     |
| Dark Indigo (288)          | ■      | ■    | ■    | ■    | ■    | ■    | ■     |
| Denim Blue (266)           | ■      | ■    | ■    | ■    | ■    | ■    | ■     |
| Emerald (205)              | ◆      | ◆    | ◆    | ◆    | ◆    | ◆    | ◆     |
| Erinite (360)              | ■      | ■    | ■    | ■    | ■    | ■    | ■     |
| Fern Green (291)           | ■      | ■    | ■    | ■    | ■    | ■    | ■     |
| Fireopal (237)             | ■      | ■    | ■    | ■    | ■    | ■    | ■     |
| Fuchsia (502)              | ■      | ■    | ■    | ■    | ■    | ■    | ■     |
| Graphite (253)             | ■      | ■    | ■    | ■    | ■    | ■    | ■     |
| Greige (284)               | ■      | ■    | ■    | ■    | ■    | ■    | ■     |
| Hyacinth (236)             | ■      | ■    | ■    | ■    | ■    | ■    | ■     |
| Indian Pink (289)          | ■      | ■    | ■    | ■    | ■    | ■    | ■     |
| Indian Sapphire (217)      | ■      | ■    | ■    | ■    | ■    | ■    | ■     |
| Indicolite (379)           | ■      | ■    | ■    | ■    | ■    | ■    | ■     |
| Jet (280)                  | ◆      | ◆    | ◆    | ◆    | ◆    | ◆    | ◆     |
| Jonquil (213)              | ■      | ■    | ■    | ■    | ■    | ■    | ■     |
| Light Amethyst (212)       | ■      | ■    | ■    | ■    | ■    | ■    | ■     |
| Light Azore (361)          | ■      | ■    | ■    | ■    | ■    | ■    | ■     |
| Light Colorado Topaz (246) | ◆      | ◆    | ◆    | ◆    | ◆    | ◆    | ◆     |
| Light Peach (362)          | ■      | ■    | ■    | ■    | ■    | ■    | ■     |
| Light Rose (223)           | ■      | ■    | ■    | ■    | ■    | ■    | ■     |
| Light Sapphire (211)       | ■      | ■    | ■    | ■    | ■    | ■    | ■     |
| Light Siam (227)           | ■      | ■    | ■    | ■    | ■    | ■    | ■     |
| Light Silk (261)           | ■      | ■    | ■    | ■    | ■    | ■    | ■     |
| Light Smoked Topaz (221)   | ■      | ■    | ■    | ■    | ■    | ■    | ■     |
| Light Topaz (226)          | ■      | ■    | ■    | ■    | ■    | ■    | ■     |
| Light Turquoise (263)      | ■      | ■    | ■    | ■    | ■    | ■    | ■     |
| Majestic Blue (296)        | ■      | ■    | ■    | ■    | ■    | ■    | ■     |

◆ Core Assortment

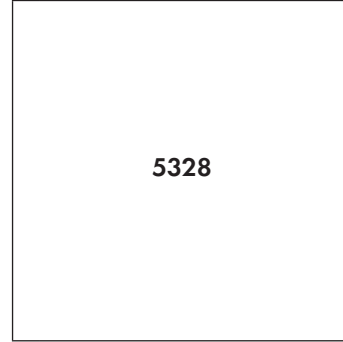

- Montana (207)
  - Olivine (228)
  - Padparadscha (542)
  - Peridot (214)
  - Provence Lavender (283)
  - Purple Velvet (277)
  - Rosaline (508)
  - Rose (209)
  - Rose Peach (262)
  - Ruby (501)
  - Sapphire (206)
  - Scarlet (276)
  - Siam (208)
  - Silk (391)
  - Smoky Mauve (265)
  - Smoked Topaz (220)
  - Sunflower (292)
  - Tangerine (259)
  - Tanzanite (539)
  - Topaz (203)
  - Turquoise (267)
  - Vintage Rose (319)
  - Violet (371)
  - White Alabaster (281)
- Opal Colors**
- Air Blue Opal (285)
  - Chrysolite Opal (294)
  - Cyclamen Opal (398)
  - Light Grey Opal (383)
  - Pacific Opal (390)
  - Rose Water Opal (395)
  - White Opal (234)
  - Yellow Opal (231)
- Crystal Effects**
- Transparent Effects**
- Crystal AB (001 AB)
  - Crystal AB 2x (001 AB2)
  - Crystal AB Satin (001 ABSAT)
  - Crystal Shimmer (001 SHIM)
  - Crystal Shimmer 2x (001 SHIM2)

|                                | 2.5 mm | 3 mm | 4 mm | 5 mm | 6 mm | 8 mm | 10 mm |
|--------------------------------|--------|------|------|------|------|------|-------|
| Montana (207)                  | ■      | ■    | ■    | ■    | ■    | ■    | ■     |
| Olivine (228)                  | ■      | ■    | ■    | ■    | ■    | ■    | ■     |
| Padparadscha (542)             | ■      | ■    | ■    | ■    | ■    | ■    | ■     |
| Peridot (214)                  | ■      | ■    | ■    | ■    | ■    | ■    | ■     |
| Provence Lavender (283)        | ■      | ■    | ■    | ■    | ■    | ■    | ■     |
| Purple Velvet (277)            | ■      | ■    | ■    | ■    | ■    | ■    | ■     |
| Rosaline (508)                 | ■      | ■    | ■    | ■    | ■    | ■    | ■     |
| Rose (209)                     | ■      | ■    | ■    | ■    | ■    | ■    | ■     |
| Rose Peach (262)               | ■      | ■    | ■    | ■    | ■    | ■    | ■     |
| Ruby (501)                     | ■      | ■    | ■    | ■    | ■    | ■    | ■     |
| Sapphire (206)                 | ■      | ■    | ■    | ■    | ■    | ■    | ■     |
| Scarlet (276)                  | ◆      | ◆    | ◆    | ◆    | ◆    | ◆    | ◆     |
| Siam (208)                     | ■      | ■    | ■    | ■    | ■    | ■    | ■     |
| Silk (391)                     | ■      | ■    | ■    | ■    | ■    | ■    | ■     |
| Smoky Mauve (265)              | ■      | ■    | ■    | ■    | ■    | ■    | ■     |
| Smoked Topaz (220)             | ■      | ■    | ■    | ■    | ■    | ■    | ■     |
| Sunflower (292)                | ■      | ■    | ■    | ■    | ■    | ■    | ■     |
| Tangerine (259)                | ■      | ■    | ■    | ■    | ■    | ■    | ■     |
| Tanzanite (539)                | ■      | ■    | ■    | ■    | ■    | ■    | ■     |
| Topaz (203)                    | ■      | ■    | ■    | ■    | ■    | ■    | ■     |
| Turquoise (267)                | ■      | ■    | ■    | ■    | ■    | ■    | ■     |
| Vintage Rose (319)             | ■      | ■    | ■    | ■    | ■    | ■    | ■     |
| Violet (371)                   | ■      | ■    | ■    | ■    | ■    | ■    | ■     |
| White Alabaster (281)          | ■      | ■    | ■    | ■    | ■    | ■    | ■     |
| Air Blue Opal (285)            | ■      | ■    | ■    | ■    | ■    | ■    | ■     |
| Chrysolite Opal (294)          | ■      | ■    | ■    | ■    | ■    | ■    | ■     |
| Cyclamen Opal (398)            | ■      | ■    | ■    | ■    | ■    | ■    | ■     |
| Light Grey Opal (383)          | ■      | ■    | ■    | ■    | ■    | ■    | ■     |
| Pacific Opal (390)             | ■      | ■    | ■    | ■    | ■    | ■    | ■     |
| Rose Water Opal (395)          | ■      | ■    | ■    | ■    | ■    | ■    | ■     |
| White Opal (234)               | ■      | ■    | ■    | ■    | ■    | ■    | ■     |
| Yellow Opal (231)              | ■      | ■    | ■    | ■    | ■    | ■    | ■     |
| Crystal AB (001 AB)            | ■      | ■    | ■    | ■    | ■    | ■    | ■     |
| Crystal AB 2x (001 AB2)        | ■      | ■    | ■    | ■    | ■    | ■    | ■     |
| Crystal AB Satin (001 ABSAT)   | ■      | ■    | ■    | ■    | ■    | ■    | ■     |
| Crystal Shimmer (001 SHIM)     | ■      | ■    | ■    | ■    | ■    | ■    | ■     |
| Crystal Shimmer 2x (001 SHIM2) | ■      | ■    | ■    | ■    | ■    | ■    | ■     |



| 5328                                      | Size | 2.5 mm | 3 mm | 4 mm | 5 mm | 6 mm | 8 mm | 10 mm |
|---|------|--------|------|------|------|------|------|-------|
|   |      |        |      |      |      |      |      |       |
| Crystal Antique Pink (001 ANTP)           |      |        | ■    | ■    | ■    | ■    |      |       |
| Crystal Astral Pink (001 API)             |      |        | ■    | ■    | ■    | ■    |      |       |
| Crystal Blue Shade (001 BLSH)             |      |        | ■    | ■    | ■    | ■    |      |       |
| Crystal Bronze Shade (001 BRSH)           |      |        | ■    | ■    | ■    | ■    |      |       |
| Crystal Copper (001 COP)                  |      |        | ■    | ■    | ■    | ■    |      |       |
| Crystal Golden Shadow (001 GSHA)          |      | ■      | ■    | ■    | ■    | ■    | ■    |       |
| Crystal Heliotrope (001 HEL)              |      |        | ■    | ■    | ■    | ■    |      |       |
| Crystal Lilac Shadow (001 LISH)           |      |        | ■    | ■    | ■    | ■    |      |       |
| Crystal Luminous Green (001 LUMG)         |      |        | ■    | ■    | ■    | ■    |      |       |
| Crystal Moonlight (001 MOL)               |      |        | ■    | ■    | ■    | ■    |      |       |
| Crystal Paradise Shine (001 PARSH)        |      |        | ■    | ■    | ■    | ■    |      |       |
| Crystal Paradise Shine 2x (001 PARSH2)    |      |        |      | ■    |      |      |      |       |
| Crystal Red Magma (001 REDM)              |      |        | ■    | ■    | ■    | ■    |      |       |
| Crystal Satin (001 SAT)                   |      |        | ■    | ■    | ■    | ■    |      |       |
| Crystal Silver Night (001 SINI)           |      |        | ■    | ■    | ■    | ■    |      |       |
| Crystal Silver Shade (001 SSHA)           |      | ■      | ■    | ■    | ■    | ■    | ■    |       |
| Crystal Vitrail Medium (001 VM)           |      |        | ■    | ■    | ■    | ■    |      |       |
| <b>Metallic Effects</b>                   |      |        |      |      |      |      |      |       |
| Crystal CAL (001 CAL)                     |      |        | ■    | ■    | ■    | ■    |      |       |
| Crystal Dorado 2x (001 DOR2)              |      |        | ■    | ■    | ■    | ■    |      |       |
| Crystal Iridescent Green (001 IRIG)       |      |        | ■    | ■    | ■    | ■    |      |       |
| Crystal Iridescent Green 2x (001 IRIG2)   |      |        |      | ■    |      |      |      |       |
| Crystal Light Chrome (001 LTCH)           |      |        | ■    | ■    | ■    | ■    |      |       |
| Crystal Light Chrome 2x (001 LTCH2)       |      |        |      | ■    |      |      |      |       |
| Crystal Metallic Blue 2x (001 METBL2)     |      |        | ■    | ■    | ■    | ■    |      |       |
| Crystal Metallic Light Gold 2x (001 MlG2) |      |        | ■    | ■    | ■    | ■    |      |       |
| Crystal Metallic Sunshine (001 METSH)     |      |        | ■    | ■    | ■    | ■    |      |       |
| Crystal Metallic Sunshine 2x (001 METSH2) |      |        |      | ■    |      |      |      |       |
| Crystal Rainbow Dark 2x (001 RBDK2)       |      |        |      |      | ■    | ■    |      |       |
| Crystal Rose Gold (001 ROGL)              |      |        | ■    | ■    | ■    | ■    |      |       |
| Crystal Rose Gold 2x (001 ROGL2)          |      |        | ■    | ■    | ■    | ■    |      |       |
| Crystal Scarabaeus Green*** (001 SCGR)    |      |        | ■    | ■    | ■    | ■    |      |       |
| <b>Color Effects</b>                      |      |        |      |      |      |      |      |       |
| <b>Transparent Effects</b>                |      |        |      |      |      |      |      |       |
| Amethyst AB (204 AB)                      |      |        | ■    | ■    | ■    | ■    |      |       |
| Amethyst AB 2x (204 AB2)                  |      |        |      | ■    |      |      |      |       |
| Amethyst Shimmer (204 SHIM)               |      |        | ■    | ■    | ■    | ■    |      |       |
| Amethyst Shimmer 2x (204 SHIM2)           |      |        | ■    | ■    | ■    | ■    |      |       |
| Aquamarine AB (202 AB)                    |      |        | ■    | ■    | ■    | ■    |      |       |
| Aquamarine AB 2x (202 AB2)                |      |        |      | ■    |      |      |      |       |

| 5328                                    | Size | 2.5 mm | 3 mm | 4 mm | 5 mm | 6 mm | 8 mm | 10 mm |
|---|------|--------|------|------|------|------|------|-------|
|   |      |        |      |      |      |      |      |       |
| Aquamarine Satin (202 SAT)              |      |        |      |      |      |      | ■    |       |
| Black Diamond AB (215 AB)               |      |        | ■    | ■    | ■    | ■    |      |       |
| Black Diamond AB 2x (215 AB2)           |      |        |      | ■    |      |      |      |       |
| Black Diamond Shimmer (215 SHIM)        |      |        | ■    | ■    | ■    | ■    |      |       |
| Black Diamond Shimmer 2x (215 962)      |      |        | ■    | ■    |      |      |      |       |
| Blue Zircon AB (229 AB)                 |      |        |      |      |      | ■    |      |       |
| Blue Zircon AB 2x (229 AB2)             |      |        |      |      |      | ■    |      |       |
| Blush Rose AB (257 AB)                  |      |        |      |      |      | ■    |      |       |
| Blush Rose AB 2x (257 AB2)              |      |        |      |      |      | ■    |      |       |
| Capri Blue AB (243 AB)                  |      |        | ■    | ■    | ■    | ■    |      |       |
| Capri Blue AB 2x (243 AB2)              |      |        |      | ■    |      |      |      |       |
| Chrysolite AB (238 AB)                  |      |        |      |      |      | ■    |      |       |
| Chrysolite AB 2x (238 AB2)              |      |        |      |      |      | ■    |      |       |
| Emerald AB (205 AB)                     |      |        | ■    | ■    | ■    | ■    |      |       |
| Emerald AB 2x (205 AB2)                 |      |        |      | ■    |      |      |      |       |
| Erinite AB (360 AB)                     |      |        |      |      |      | ■    |      |       |
| Erinite Shimmer (360 SHIM)              |      |        | ■    | ■    | ■    | ■    |      |       |
| Erinite Shimmer 2x (360 962)            |      |        | ■    | ■    | ■    | ■    |      |       |
| Fireopal AB (237 AB)                    |      |        |      |      |      | ■    |      |       |
| Fireopal AB 2x (237 AB2)                |      |        |      |      |      | ■    |      |       |
| Fuchsia AB (502 AB)                     |      |        | ■    | ■    | ■    | ■    |      |       |
| Fuchsia AB 2x (502 AB2)                 |      |        |      | ■    |      |      |      |       |
| Graphite AB (253 AB)                    |      |        |      |      |      | ■    |      |       |
| Graphite AB 2x (253 AB2)                |      |        |      |      |      | ■    |      |       |
| Hyacinth AB (236 AB)                    |      |        |      |      |      | ■    |      |       |
| Hyacinth AB 2x (236 AB2)                |      |        |      |      |      | ■    |      |       |
| Indian Sapphire AB (217 AB)             |      |        |      |      |      | ■    |      |       |
| Indicolite AB (379 AB)                  |      |        |      |      |      | ■    |      |       |
| Jet AB (280 AB)                         |      |        | ■    | ■    | ■    | ■    |      |       |
| Jet AB 2x (280 AB2)                     |      |        | ■    | ■    |      |      |      |       |
| Jonquil AB (213 AB)                     |      |        |      |      |      | ■    |      |       |
| Jonquil AB 2x (213 AB2)                 |      |        |      |      |      | ■    |      |       |
| Jonquil Satin (213 SAT)                 |      |        |      |      |      | ■    |      |       |
| Light Amethyst AB (212 AB)              |      |        | ■    | ■    | ■    | ■    |      |       |
| Light Amethyst AB 2x (212 AB2)          |      |        |      | ■    |      |      |      |       |
| Light Azore AB (361 AB)                 |      |        |      |      |      | ■    |      |       |
| Light Azore AB 2x (361 AB2)             |      |        |      |      |      | ■    |      |       |
| Light Colorado Topaz AB (246 AB)        |      |        | ■    | ■    | ■    | ■    |      |       |
| Light Colorado Topaz AB 2x (246 AB2)    |      |        |      | ■    |      |      |      |       |
| Light Colorado Topaz Shimmer (246 SHIM) |      |        | ■    | ■    | ■    | ■    |      |       |

| 5328                                      | Size   |      |      |      |      |      |       |
|---|--------|------|------|------|------|------|-------|
|   | 2.5 mm | 3 mm | 4 mm | 5 mm | 6 mm | 8 mm | 10 mm |
| Light Colorado Topaz Shimmer 2x (246 962) |        | ■    | ■    |      |      |      |       |
| Light Peach AB (362 AB)                   |        |      | ■    |      |      |      |       |
| Light Peach Satin (362 SAT)               |        |      | ■    |      |      |      |       |
| Light Rose AB (223 AB)                    |        | ■    | ■    | ■    | ■    |      |       |
| Light Rose AB 2x (223 AB2)                |        |      | ■    |      |      |      |       |
| Light Rose Satin (223 SAT)                |        |      | ■    |      |      |      |       |
| Light Sapphire AB (211 AB)                |        | ■    | ■    |      |      |      |       |
| Light Sapphire AB 2x (211 AB2)            |        |      | ■    |      |      |      |       |
| Light Sapphire Shimmer (211 SHIM)         |        | ■    | ■    | ■    | ■    |      |       |
| Light Sapphire Shimmer 2x (211 962)       |        | ■    | ■    |      |      |      |       |
| Light Siam AB (227 AB)                    |        | ■    | ■    | ■    | ■    |      |       |
| Light Siam AB 2x (227 AB2)                |        |      | ■    |      |      |      |       |
| Light Siam Satin (227 SAT)                |        |      | ■    |      |      |      |       |
| Light Siam Shimmer (227 SHIM)             |        | ■    | ■    | ■    | ■    |      |       |
| Light Siam Shimmer 2x (227 962)           |        | ■    | ■    |      |      |      |       |
| Light Smoked Topaz AB (221 AB)            |        |      | ■    |      |      |      |       |
| Light Topaz AB (226 AB)                   |        |      | ■    |      |      |      |       |
| Light Topaz AB 2x (226 AB2)               |        |      | ■    |      |      |      |       |
| Light Topaz Shimmer (226 SHIM)            |        | ■    | ■    | ■    | ■    |      |       |
| Light Topaz Shimmer 2x (226 962)          |        | ■    | ■    |      |      |      |       |
| Majestic Blue AB (296 AB)                 |        | ■    | ■    | ■    | ■    |      |       |
| Majestic Blue AB 2x (296 AB2)             |        | ■    | ■    |      |      |      |       |
| Montana AB (207 AB)                       |        | ■    | ■    |      |      |      |       |
| Montana AB 2x (207 AB2)                   |        |      | ■    |      |      |      |       |
| Olivine AB (228 AB)                       |        | ■    | ■    |      |      |      |       |
| Pacific Opal AB 2x (390 AB2)              |        |      | ■    |      |      |      |       |
| Peridot AB (214 AB)                       |        |      | ■    |      |      |      |       |
| Peridot AB 2x (214 AB2)                   |        |      | ■    |      |      |      |       |
| Purple Velvet AB (277 AB)                 |        |      | ■    |      |      |      |       |
| Rose AB (209 AB)                          |        | ■    | ■    | ■    | ■    |      |       |
| Rose AB 2x (209 AB2)                      |        |      | ■    |      |      |      |       |
| Rose Satin (209 SAT)                      |        |      | ■    |      |      |      |       |
| Rose Water Opal AB 2x (395 AB2)           |        |      | ■    |      |      |      |       |
| Ruby AB (501 AB)                          |        |      | ■    |      |      |      |       |
| Sapphire AB (206 AB)                      |        | ■    | ■    |      |      |      |       |
| Sapphire AB 2x (206 AB2)                  |        |      | ■    |      |      |      |       |
| Scarlet AB (276 AB)                       |        | ■    | ■    |      |      |      |       |
| Scarlet AB 2x (276 AB2)                   |        | ■    | ■    |      |      |      |       |
| Siam AB (208 AB)                          |        |      | ■    |      |      |      |       |
| Siam AB 2x (208 AB2)                      |        |      | ■    |      |      |      |       |

| 5328                            | Size   |      |      |      |      |      |       |
|---------------------------------|--------|------|------|------|------|------|-------|
|                                 | 2.5 mm | 3 mm | 4 mm | 5 mm | 6 mm | 8 mm | 10 mm |
| Smoked Topaz AB (220 AB)        |        |      | ■    |      |      |      |       |
| Smoky Mauve AB (265 AB)         |        |      | ■    |      |      |      |       |
| Smoky Mauve AB 2x (265 AB2)     |        |      | ■    |      |      |      |       |
| Tanzanite AB (539 AB)           |        | ■    | ■    |      |      |      |       |
| Tanzanite AB 2x (539 AB2)       |        |      | ■    |      |      |      |       |
| Topaz AB (203 AB)               |        |      | ■    |      |      |      |       |
| Topaz AB 2x (203 AB2)           |        |      | ■    |      |      |      |       |
| Turquoise AB (267 AB)           |        | ■    | ■    |      |      |      |       |
| Turquoise AB 2x (267 AB2)       |        | ■    | ■    |      |      |      |       |
| Violet AB (371 AB)              |        | ■    | ■    |      |      |      |       |
| Violet AB 2x (371 AB2)          |        |      | ■    |      |      |      |       |
| White Alabaster AB 2x (281 AB2) |        |      | ■    |      |      |      |       |
| White Opal AB (234 AB)          |        | ■    | ■    |      |      |      |       |
| White Opal AB 2x (234 AB2)      |        |      | ■    |      |      |      |       |
| Yellow Opal AB (231 AB)         |        |      | ■    |      |      |      |       |
| Yellow Opal AB 2x (231 AB2)     |        |      | ■    |      |      |      |       |
| <b>Metallic Effects</b>         |        |      |      |      |      |      |       |
| Jet Hematite (280 HEM)          |        | ■    | ■    | ■    | ■    |      |       |
| Jet Hematite 2x (280 HEM2)      |        | ■    | ■    | ■    | ■    |      |       |

5378 Cross Bead

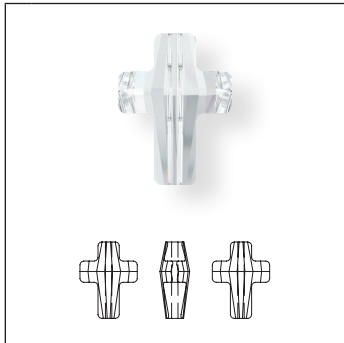

|      |       |       |
|------|-------|-------|
| Size | 14 mm | 18 mm |
|------|-------|-------|

- Crystal**
- Crystal (001)
- Colors**
- Plain Colors**
- Jet (280)
- Crystal Effects**
- Transparent Effects**
- Crystal AB (001 AB)
- Crystal Golden Shadow (001 GSHA)
- Crystal Paradise Shine (001 PARSH)
- Crystal Silver Night (001 SINI)
- Crystal Patina Effect**
- Crystal Silver Patina (001 SILPA)

5500



|      |        |         |
|------|--------|---------|
| Size | 9x6 mm | 12x8 mm |
|------|--------|---------|

- Crystal**
- Crystal (001)
- Colors**
- Plain Colors**
- Jet (280)
- Siam (208)
- Crystal Effects**
- Transparent Effects**
- Crystal AB (001 AB)

5514 Pendulum Bead

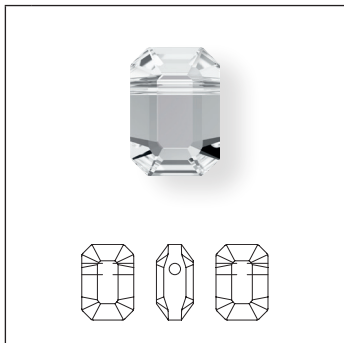

|      |          |         |
|------|----------|---------|
| Size | 8x5.5 mm | 10x7 mm |
|------|----------|---------|

- Crystal**
- Crystal (001)
- Colors**
- Plain Colors**
- Emerald (205)
- Jet (280)
- Crystal Effects**
- Transparent Effects**
- Crystal AB (001 AB)
- Crystal Silver Night (001 SINI)
- Metallic Effects**
- Crystal Metallic Sunshine (001 METSH)

5515 Emerald Cut Bead

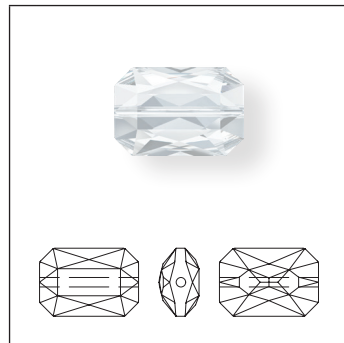

|      |           |            |
|------|-----------|------------|
| Size | 14x9.5 mm | 18x12.5 mm |
|------|-----------|------------|

- Crystal**
- Crystal (001)
- Colors**
- Plain Colors**
- Amethyst (204)
- Aquamarine (202)
- Blush Rose (257)
- Emerald (205)
- Jet (280)
- Crystal Effects**
- Transparent Effects**
- Crystal Golden Shadow (001 GSHA)

5523 Cosmic Bead

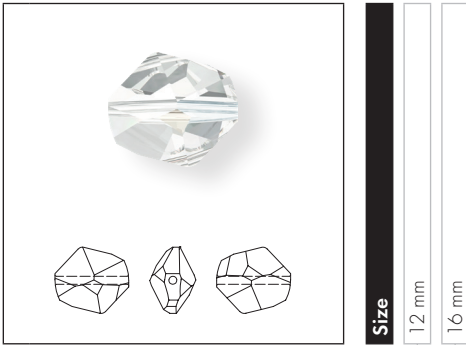

Size  
12 mm  
16 mm

- Crystal**
- Crystal (001)
- Crystal Effects**
- Transparent Effects**
- Crystal AB (001 AB)
- Crystal Golden Shadow (001 GSHA)

5540 Artemis Bead

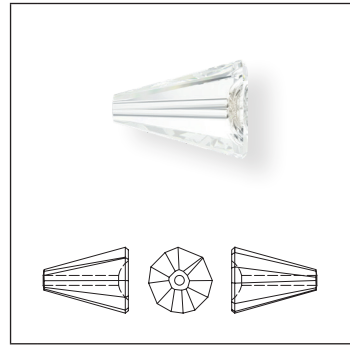

Size  
12 mm  
17 mm

- Crystal**
- Crystal (001)
- Colors**
- Plain Colors**
- Amethyst (204)
- Aquamarine (202)
- Crystal Effects**
- Transparent Effects**
- Crystal AB (001 AB)
- Crystal Golden Shadow (001 GSHA)

5541 Dome Bead large

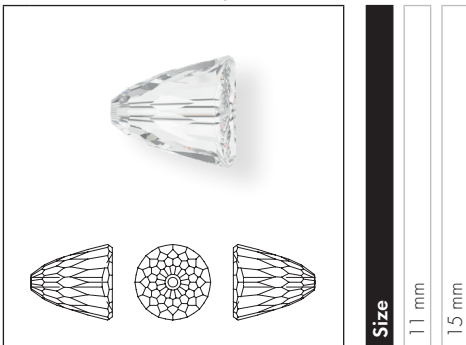

Size  
11 mm  
15 mm

- Crystal**
- Crystal (001)
- Colors**
- Plain Colors**
- Smoky Mauve (265)
- Crystal Effects**
- Transparent Effects**
- Crystal AB (001 AB)
- Crystal Golden Shadow (001 GSHA)
- Crystal Paradise Shine (001 PARSH)

5542 Dome Bead small



Size  
8 mm  
11 mm

- Crystal**
- Crystal (001)
- Crystal Effects**
- Transparent Effects**
- Crystal AB (001 AB)
- Crystal Golden Shadow (001 GSHA)

5601

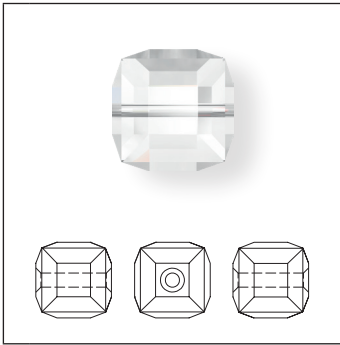

| Size | 4 mm | 6 mm | 8 mm | 10 mm | 12 mm |
|------|------|------|------|-------|-------|
|------|------|------|------|-------|-------|

**Crystal**

Crystal (001)

**Colors**

**Plain Colors**

Amethyst (204)

Aquamarine (202)

Blush Rose (257)

Emerald (205)

Fuchsia (502)

Jet (280)

Light Siam (227)

Light Topaz (226)

Light Turquoise (263)

Majestic Blue (296)

Peridot (214)

Sapphire (206)

Siam (208)

Tanzanite (539)

Topaz (203)

**Crystal Effects**

**Transparent Effects**

Crystal AB B (001 ABB)

Crystal Blue Shade B (001 BLSHB)

Crystal Golden Shadow B (001 GSHAB)

Crystal Silver Night B (001 SINIB)

Crystal Vitrail Medium B (001 VMB)

**Metallic Effects**

Crystal Light Chrome B (001 LTCHB)

Crystal Metallic Sunshine (001 METSH)

Crystal Rose Gold B (001 ROGLB)

Crystal Rose Gold B 2x (001 ROGL2B)

5621 Twist Bead

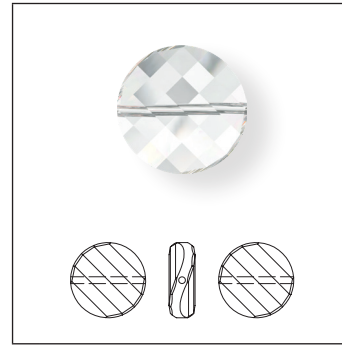

| Size | 14 mm | 18 mm |
|------|-------|-------|
|------|-------|-------|

**Crystal**

Crystal (001)

**Colors**

**Plain Colors**

Amethyst (204)

Aquamarine (202)

**Crystal Effects**

**Transparent Effects**

Crystal Golden Shadow (001 GSHA)

5624 Stairway Bead

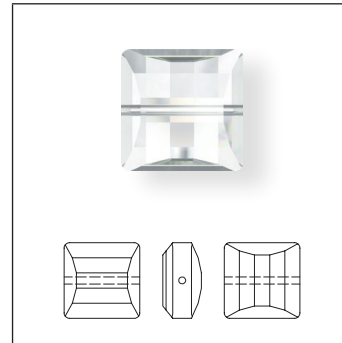

| Size | 10 mm | 14 mm |
|------|-------|-------|
|------|-------|-------|

**Crystal**

Crystal (001)

**Crystal Effects**

**Transparent Effects**

Crystal AB (001 AB)

Crystal Golden Shadow (001 GSHA)

5714 Star Bead

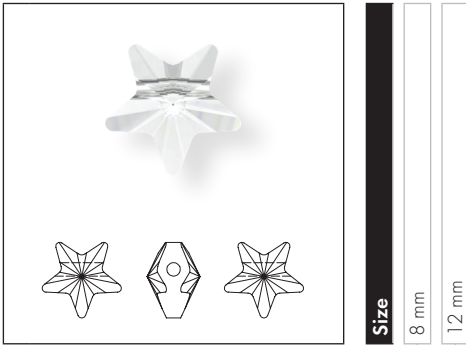

Size  
8 mm  
12 mm

- Crystal**
- Crystal (001)
- Crystal Effects**
- Transparent Effects**
- Crystal AB (001 AB)
- Crystal Golden Shadow (001 GSHA)

5727 Fish Bead

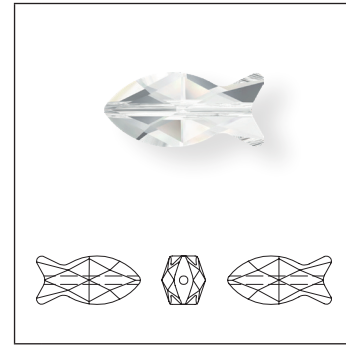

Size  
14 mm

- Crystal**
- Crystal (001)
- Crystal Effects**
- Transparent Effects**
- Crystal AB (001 AB)
- Crystal Golden Shadow (001 GSHA)

5728 Scarab Bead



Size  
12 mm

- Crystal**
- Crystal (001)
- Colors**
- Plain Colors**
- Amethyst (204)
- Aquamarine (202)
- Emerald (205)
- Jet (280)
- Crystal Effects**
- Transparent Effects**
- Crystal AB (001 AB)
- Crystal Golden Shadow (001 GSHA)
- Crystal Silver Night (001 SINI)
- Metallic Effects**
- Crystal Metallic Sunshine (001 METSH)
- Crystal Scarabaeus Green\*\*\* (001 SCGR)
- Crystal Scarabaeus Green\*\*\* 2x (001 SCGR2)

5741 Love Bead

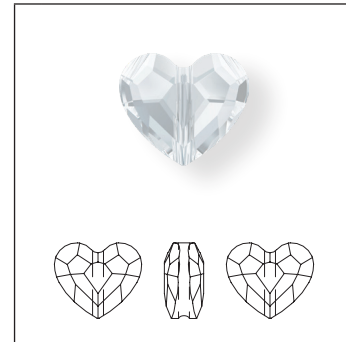

Size  
8 mm  
12 mm

- Crystal**
- Crystal (001)
- Colors**
- Plain Colors**
- Blush Rose (257)
- Fuchsia (502)
- Jet (280)
- Light Siam (227)
- Rose (209)
- Crystal Effects**
- Transparent Effects**
- Crystal AB (001 AB)
- Crystal Golden Shadow (001 GSHA)
- Crystal Paradise Shine (001 PARSH)
- Crystal Silver Night 2x (001 SINI2)
- Metallic Effects**
- Crystal Metallic Sunshine (001 METSH)

\*\*\* designed by Jean Paul Gaultier

5742 Heart Bead

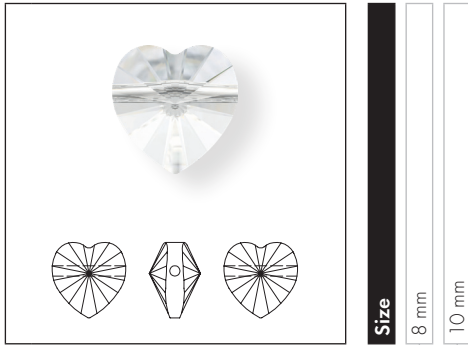

Size  
8 mm  
10 mm

Crystal

- Crystal (001)
- Crystal Effects**
- Transparent Effects**
- Crystal AB (001 AB)
- Crystal Golden Shadow (001 GSHA)

5744 Flower Bead

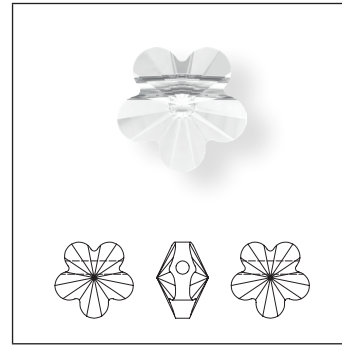

Size  
6 mm  
8 mm

Crystal

- Crystal (001)
- Crystal Effects**
- Transparent Effects**
- Crystal AB (001 AB)

5747 Double Spike Bead

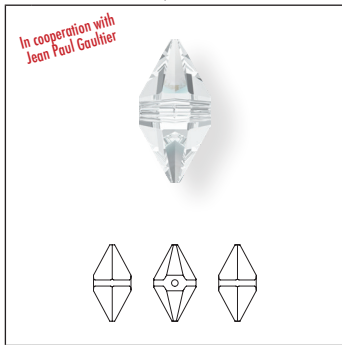

Size  
12x6 mm  
16x8 mm

Crystal

- Crystal (001)
- Colors**
- Plain Colors**
- Jet (280)
- Crystal Effects**
- Transparent Effects**
- Crystal AB (001 AB)
- Crystal Golden Shadow (001 GSHA)
- Crystal Lilac Shadow (001 LISH)
- Crystal Silver Night (001 SINI)
- Crystal Silver Shade (001 SSJA)
- Metallic Effects**
- Crystal Metallic Blue 2x (001 METBL2)

5750 Skull Bead



Size  
13 mm  
19 mm

Crystal

- Crystal (001)
- Colors**
- Plain Colors**
- Denim Blue (266)
- Jet (280)
- Crystal Effects**
- Transparent Effects**
- Crystal AB (001 AB)
- Crystal Golden Shadow (001 GSHA)
- Crystal Paradise Shine (001 PARSH)
- Crystal Red Magma (001 REDM)
- Crystal Silver Night (001 SINI)
- Crystal Silver Night 2x (001 SINI2)
- Metallic Effects**
- Crystal Iridescent Green (001 IRIG)
- Crystal Light Chrome (001 LTCH)
- Crystal Light Chrome 2x (001 LTCH2)
- Crystal Metallic Blue 2x (001 METBL2)
- Crystal Metallic Light Gold 2x (001 MLG2)
- Crystal Metallic Sunshine (001 METSH)
- Crystal Rose Gold 2x (001 ROGL2)

**5752** Clover Bead

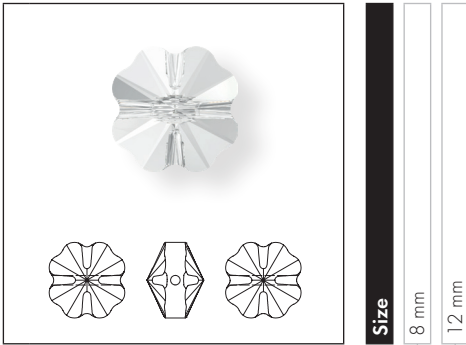

**Size**  
8 mm  
12 mm

|                                  |  |   |   |
|----------------------------------|--|---|---|
| <b>Crystal</b>                   |  |   |   |
| Crystal (001)                    |  | ■ | ■ |
| <b>Colors</b>                    |  |   |   |
| <b>Plain Colors</b>              |  |   |   |
| Light Siam (227)                 |  | ■ |   |
| Peridot (214)                    |  | ■ | ■ |
| <b>Crystal Effects</b>           |  |   |   |
| <b>Transparent Effects</b>       |  |   |   |
| Crystal AB (001 AB)              |  | ■ | ■ |
| Crystal Golden Shadow (001 GSHA) |  | ■ | ■ |

**5754** Butterfly Bead

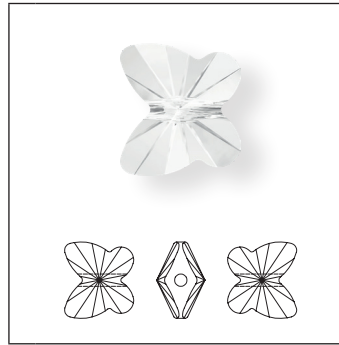

**Size**  
6 mm  
8 mm  
10 mm  
12 mm

|                                    |  |   |   |   |   |
|------------------------------------|--|---|---|---|---|
| <b>Crystal</b>                     |  |   |   |   |   |
| Crystal (001)                      |  | ■ | ■ | ■ | ■ |
| <b>Colors</b>                      |  |   |   |   |   |
| <b>Plain Colors</b>                |  |   |   |   |   |
| Aquamarine (202)                   |  | ■ | ■ | ■ |   |
| Fuchsia (502)                      |  | ■ | ■ | ■ |   |
| Jet (280)                          |  | ■ | ■ | ■ |   |
| Jonquil (213)                      |  | ■ | ■ | ■ |   |
| Light Rose (223)                   |  | ■ | ■ | ■ |   |
| Light Siam (227)                   |  | ■ | ■ | ■ |   |
| Peridot (214)                      |  | ■ | ■ | ■ |   |
| Violet (371)                       |  | ■ | ■ | ■ |   |
| <b>Crystal Effects</b>             |  |   |   |   |   |
| <b>Transparent Effects</b>         |  |   |   |   |   |
| Crystal AB (001 AB)                |  | ■ | ■ | ■ | ■ |
| Crystal Golden Shadow (001 GSHA)   |  | ■ | ■ | ■ | ■ |
| Crystal Paradise Shine (001 PARSH) |  | ■ | ■ | ■ | ■ |



**FINE ROCKS TUBE**

**5950** Fine Rocks Tube with ending

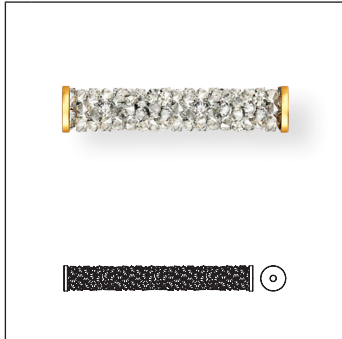

- Crystal Effects**
- Transparent Effects**
  - Crystal Bermuda Blue (001 BBL)
  - Crystal Golden Shadow (001 GSHA)
  - Crystal Moonlight (001 MOL)
- Metallic Effects**
  - Crystal Light Chrome (001 LTCH)
- Multicolors**
  - Jet &
  - Crystal Metallic Silver (001 M100)

**5951** Fine Rocks Tube without ending



- Crystal Effects**
- Transparent Effects**
  - Crystal Bermuda Blue (001 BBL)
  - Crystal Golden Shadow (001 GSHA)
  - Crystal Moonlight (001 MOL)
- Metallic Effects**
  - Crystal Light Chrome (001 LTCH)
- Multicolors**
  - Jet &
  - Crystal Metallic Silver (001 M100)

**Overview of all available Colors of Metal Parts**

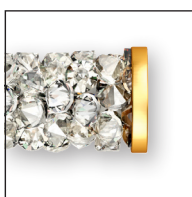

081 Gold Coating



088 Stainless Steel

**Important Notice**

This component is expertly crafted and should be treated with special care, as it has a rough surface that may come into contact with skin or delicate fabrics when incorporated into other products.

Do not bend it nor remove its end caps during further processing in order to avoid any damage to the component.

**Care Instructions**



Turn inside out and use mild laundry detergent (wash by hand, max. temp. 30°C, very mild process).



Do not use chlorine bleach!



Do not tumble dry!



Do not iron!

## COMPLEMENTARY PRODUCTS

These protective plastic spacer rings are recommended for use between Beads, increasing the durability of the designs and enabling the use of larger Beads and more complex cuts.

Please order art. 7800 Nr. 646 with Sys.no. 977980 (**packing unit = 100 pcs**) and art. 7800 Nr. 647 with Sys.no. 977981 (**packing unit = 1,000 pcs**).

### 7800 Protective Spacer Rings

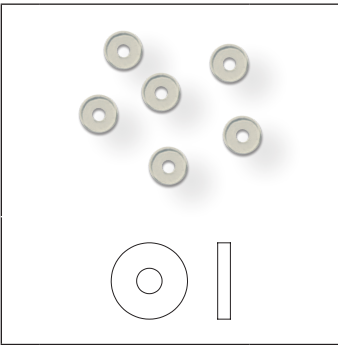

|          |                    |             |
|----------|--------------------|-------------|
| <b>C</b> | Transparent        |             |
| <b>S</b> | 3 mm (hole 1 mm)   |             |
| <b>M</b> | 100 PCS (Nr 646)   |             |
|          | 1,000 PCS (Nr 647) | <b>150%</b> |

## PRODUCT DETAILS

| Article Size  | Packing Unit =<br>Minimum Order<br>Quantity in Pieces | Average Net<br>Weight in Gram<br>per Packing Unit<br>Crystal (001) | Average Gross<br>Weight in Gram<br>per Packing Unit<br>Crystal (001) |
|---------------|---|--|--|
| <b>5000</b>   |   |  |  |
| 2 mm          | 1,440   | 11.5   | 20.8   |
| 3 mm          | 720   | 23.6   | 33.4   |
| 4 mm          | 720   | 53.5   | 62.6   |
| 5 mm          | 720   | 105.3  | 116.3  |
| 6 mm          | 360   | 81.6   | 92.5   |
| 7 mm          | 288   | 126.2  | 159.2  |
| 8 mm          | 288   | 193.5  | 200.8  |
| 10 mm         | 144   | 180.6  | 199.4  |
| 12 mm         | 72  | 144.2  | 166.1  |
| 14 mm         | 72  | 247.1  | 280.5  |
| <b>5003</b>   |   |  |  |
| 6 mm          | 360   | 109.9  | 120.8  |
| 8 mm          | 144   | 100.4  | 118.6  |
| 10 mm         | 144   | 195.9  | 219.2  |
| 12 mm         | 72  | 158.5  | 179.2  |
| 14 mm         | 48  | 172.4  | 193.0  |
| <b>5005</b>   |   |  |  |
| 8 mm          | 216   | 145.4  | 172.1  |
| 12 mm         | 72  | 154.3  | 175.4  |
| 16 mm         | 24  | 122.1  | 146.7  |
| <b>5020</b>   |   |  |  |
| 6 mm          | 360   | 74.5   | 85.2   |
| 8 mm          | 288   | 146.6  | 178.2  |
| 10 mm         | 144   | 116.4  | 139.2  |
| <b>5028/4</b> |   |  |  |
| 6 mm          | 360   | 75.791   | 83.4   |
| 8 mm          | 144   | 74.714   | 85.6   |
| 10 mm         | 72  | 70.763   | 76.5   |
| <b>5040</b>   |   |  |  |
| 4 mm          | 720   | 41.3   | 50.4   |
| 6 mm          | 360   | 71.8   | 82.9   |
| 8 mm          | 288   | 135.6  | 163.7  |
| 12 mm         | 144   | 214.4  | 242.4  |
| <b>5041</b>   |   |  |  |
| 18 mm         | 24  | 114.2  | 133.0  |
| <b>5045</b>   |   |  |  |
| 6 mm          | 288   | 60.7   | 70.9   |
| 8 mm          | 216   | 117.5  | 145.9  |
| <b>5058</b>   |   |  |  |
| 10 mm         | 72  | 37.1   | 57.3   |
| 14 mm         | 36  | 50.4   | 71.0   |
| <b>5060</b>   |   |  |  |
| 5.5 mm        | 288   | 49.40  | 62.92  |
| 7.5 mm        | 144   | 48.82  | 72.67  |
| <b>5061</b>   |   |  |  |
| 5.5 mm        | 288   | 62.65  | 75.50  |
| 7.5 mm        | 144   | 46.37  | 71.85  |

| Article Size | Packing Unit =<br>Minimum Order<br>Quantity in Pieces | Average Net<br>Weight in Gram<br>per Packing Unit<br>Crystal (001) | Average Gross<br>Weight in Gram<br>per Packing Unit<br>Crystal (001) |
|--------------|---|--|--|
| <b>5062</b>  |   |  |  |
| 5.5 mm       | 288   | 50.85  | 67.95  |
| 7.5 mm       | 144   | 40.32  | 62.16  |
| <b>5200</b>  |   |  |  |
| 6x4 mm       | 360   | 44.1   | 53.2   |
| 7.5x5 mm     | 360   | 80.0   | 91.0   |
| <b>5305</b>  |   |  |  |
| 5 mm         | 720   | 52.7   | 63.9   |
| 6 mm         | 360   | 50.5   | 61.4   |
| <b>5328</b>  |   |  |  |
| 2.5 mm       | 1,440   | 23.8   | 31.4   |
| 3 mm         | 1,440   | 34.1   | 45.2   |
| 4 mm         | 1,440   | 81.8   | 89.2   |
| 5 mm         | 720   | 89.3   | 100.0  |
| 6 mm         | 360   | 73.7   | 84.6   |
| 8 mm         | 288   | 141.8  | 173.4  |
| 10 mm        | 144   | 140.4  | 154.0  |
| <b>5378</b>  |   |  |  |
| 14 mm        | 72  | 55.6   | 83.87  |
| 18 mm        | 48  | 81.7   | 103.06   |
| <b>5500</b>  |   |  |  |
| 9x6 mm       | 144   | 59.0   | 69.9   |
| 12x8 mm      | 144   | 144.0  | 164.1  |
| <b>5514</b>  |   |  |  |
| 8x5.5 mm     | 144   | 72.7   | 67.8   |
| 10x7 mm      | 96  | 48.9   | 70.7   |
| <b>5515</b>  |   |  |  |
| 14x9.5 mm    | 36  | 36.3   | 56.5   |
| 18x12.5 mm   | 24  | 52.1   | 74.2   |
| <b>5523</b>  |   |  |  |
| 12 mm        | 144   | 143.2  | 173.6  |
| 16 mm        | 72  | 156.1  | 194.7  |
| <b>5540</b>  |   |  |  |
| 12 mm        | 72  | 62.1   | 86.7   |
| 17 mm        | 48  | 108.9  | 133.5  |
| <b>5541</b>  |   |  |  |
| 11 mm        | 96  | 105.6  | 129.3  |
| 15 mm        | 48  | 126.2  | 146.2  |
| <b>5542</b>  |   |  |  |
| 8 mm         | 96  | 81.4   | 102.9  |
| 11 mm        | 48  | 97.6   | 118.6  |
| <b>5601</b>  |   |  |  |
| 4 mm         | 288   | 43.9   | 65.2   |
| 6 mm         | 144   | 70.6   | 88.9   |
| 8 mm         | 96  | 100.2  | 118.4  |
| 10 mm        | 72  | 138.0  | 156.5  |
| 12 mm        | 36  | 129.6  | 147.7  |

| Article Size | Packing Unit =<br>Minimum Order<br>Quantity in Pieces | Average Net<br>Weight in Gram<br>per Packing Unit<br>Crystal (001) | Average Gross<br>Weight in Gram<br>per Packing Unit<br>Crystal (001) |
|--------------|---|--|--|
| <b>5621</b>  |   |  |  |
| 14 mm        | 96  | 168.7  | 202.1  |
| 18 mm        | 72  | 253.1  | 283.8  |
| <b>5624</b>  |   |  |  |
| 10 mm        | 108   | 117.51   | 134.2  |
| 14 mm        | 72  | 174.77   | 204.5  |
| <b>5714</b>  |   |  |  |
| 8 mm         | 288   | 73.3   | 102.1  |
| 12 mm        | 108   | 72.3   | 102.2  |
| <b>5727</b>  |   |  |  |
| 14 mm        | 108   | 72.3   | 105.4  |
| <b>5728</b>  |   |  |  |
| 12 mm        | 96  | 59.5   | 85.1   |
| <b>5741</b>  |   |  |  |
| 8 mm         | 144   | 43.3   | 66.24  |
| 12 mm        | 72  | 66.2   | 89.58  |
| <b>5742</b>  |   |  |  |
| 8 mm         | 288   | 120.5  | 154.5  |
| 10 mm        | 288   | 233.1  | 266.5  |
| <b>5744</b>  |   |  |  |
| 6 mm         | 360   | 47.4   | 58.1   |
| 8 mm         | 288   | 80.2   | 112.3  |
| <b>5747</b>  |   |  |  |
| 12x6 mm      | 144   | 64.4   | 81.2   |
| 16x8 mm      | 96  | 104.8  | 124.4  |
| <b>5750</b>  |   |  |  |
| 13 mm        | 12  | 24.2   | 43.8   |
| 19 mm        | 12  | 73.7   | 100.0  |
| <b>5752</b>  |   |  |  |
| 8 mm         | 288   | 106.1  | 136.9  |
| 12 mm        | 96  | 117.7  | 137.5  |
| <b>5754</b>  |   |  |  |
| 6 mm         | 360   | 42.3   | 53.0   |
| 8 mm         | 288   | 77.9   | 109.8  |
| 10 mm        | 288   | 156.9  | 188.9  |
| 12 mm        | 144   | 136.7  | 168.9  |
| <b>5950</b>  |   |  |  |
| 15 mm        | 10  | 12.00  | 12.01  |
| 30 mm        | 10  | 18.60  | 18.61  |
| <b>5951</b>  |   |  |  |
| 15 mm        | 10  | 6.80   | 6.81   |
| 30 mm        | 10  | 13.90  | 13.91  |
| <b>7800</b>  |   |  |  |
| Nr. 646      | 100   | -  | -  |
| Nr. 647      | 1,000   | -  | -  |

